

The VELUX logo is positioned in the top right corner of the page. It consists of the word "VELUX" in a bold, white, sans-serif font, with a registered trademark symbol (®) to its upper right. The text is set against a solid red rectangular background.

BROCHURE
October 2018

Create a healthier indoor climate

VELUX ACTIVE

Smart sensor-based operation of your VELUX roof windows, blinds and shutters.

with
NETATMO

Around 90 % of our time is spent between four walls – living, working, learning and playing.

An unhealthy indoor environment can lead to the emergence of health problems.

To help to create a healthy indoor environment VELUX has introduced the VELUX ACTIVE.

A woman with long brown hair and bangs is sitting on a grey sofa, reading a newspaper. She is wearing a white top and a dark skirt. The room is bright, with light streaming in from two large skylights. One skylight is partially open, showing a view of a city with a prominent church spire. In the foreground, a wooden coffee table holds a large, dark, sleek remote control.

NEW!
VELUX ACTIVE

Index

This brochure contains general information about our products. For detailed information, please contact VELUX-INT (VELUX A/S).

Roof Windows10
Installation Products15
Flashings16
Interior Blinds18
Exterior Awning Blinds.24
Exterior Roller Shutters	25
Electric Accessories26
Manual Accessories.27
Sun Tunnels.	28
Flat Roof Windows	30

VELUX Contacts:

VELUX INTERNATIONAL (VELUX A/S)
E-mail: velux-int@velux.com
Internet: www.velux.com



VELUX ACTIVE

Smart sensor-based operation of your VELUX roof windows, blinds and shutters.

with
NETATMO



Take control

Operate your roof windows, exterior roller shutters and electric awnings VELUX INTEGRA® from any location with the intuitive application of VELUX ACTIVE. Requires the VELUX gateway.



HomeKit is a registered trademark of Apple Inc.
App Store is a service mark of Apple Inc.
Google Play and the Google Play logo are trademarks of Google LLC.

For an automatic, healthier home

What is a healthy indoor environment? It's not something you can see, but rather, feel: you have more energy, can breathe more easily, sleep soundly. Nowadays, up to 90 %* of our time is spent inside of buildings, so it is increasingly important to maintain good indoor air quality. We introduce VELUX ACTIVE with NETATMO – to give you and your family a healthier home.

VELUX ACTIVE works flawlessly with roof windows, exterior roller shutters and electric awnings. VELUX INTEGRA®, combining the benefits of an automatic sensor-based operation with the convenience of a remote control. Together they offer you the best indoor climate control.

* Source: Healthy Home Barometer



Sensor-based ventilation

Intelligent sensors monitor temperature, humidity and CO₂ levels operating your roof windows properly for a healthier indoor climate.

Automatic ventilation 3 times per day

Depending of local climate conditions, the system will ventilate three times a day, giving you a healthier home.

Intelligent heat protection

The system protectively closes VELUX INTEGRA® external roller shutters and awnings based on the local weather forecast, e.g. an imminent heat wave.

Voice control

Compatibility with Apple HomeKit® allows to use voice control to operate VELUX roof windows, exterior roller shutters and electric awnings.

Easy departure

Press the departure switch when leaving the house to close your VELUX INTEGRA® roof windows and secure ventilation in a "safe mode".

Easy installation

VELUX ACTIVE can be easily installed and set without any assistance from a professional.

VELUX ACTIVE Indoor climate control KIX 300

Package containing an indoor climate sensor, a departure switch and a gateway to connect to the Internet. Mobile app is free.

Additional components are available for indoor climate control in each room



Indoor climate sensor VELUX ACTIVE
KLA 300 EU



Departure switch VELUX ACTIVE
KLN 300 EU



Find out more on www.velux.com

Get more
daylight

Get more
comfort

Use less
energy

Insulate your roof with daylight and fresh air



Get more daylight

Daylight is good for both body and mind, and the more of it we get, the healthier we are. The design of VELUX roof window allows more daylight into the room.



Get more comfort

A comfortable home is one that provides lots of fresh air, natural daylight, pleasant temperatures, security and peace of mind. VELUX roof window does all that and more.



Use less energy

The world is waking up to the costs of high energy consumption. By using the forces of nature to provide indoor comfort, VELUX roof window lowers energy bills and CO₂ emissions.

ThermoTechnology™¹



Get more
daylight
Get more
comfort
Use less
energy

Intelligent design improves the energy efficiency

VELUX roof windows delivers outstanding energy efficiency

Daylight and heat from the sun are free sources of energy that can minimise your energy use and bring down heating bills. Our latest roof windows bring more daylight and warmth into your home, thanks to slimmer frames, larger panes and improved insulation with ThermoTechnology™.



Two layers of glass provide improved passive solar heating in winter and an excellent energy balance.

Slimmer frames and a larger pane bring your home additional daylight and solar heat.

ThermoTechnology™ improves insulation via special materials.

ThermoTechnology™

VELUX Size Chart

Roof Windows

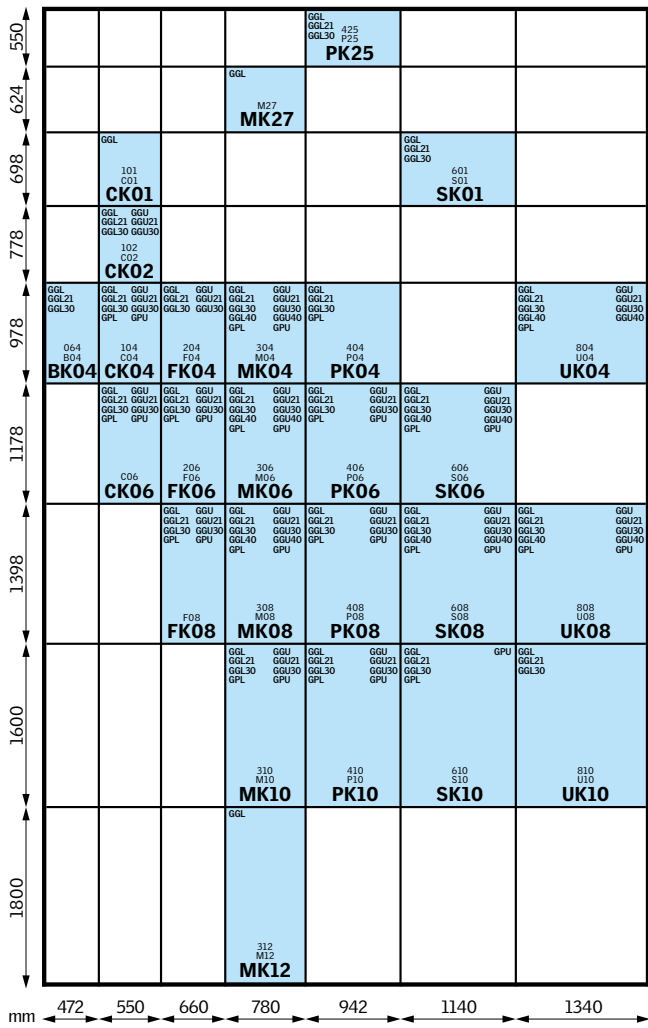

Roof Exit for Cold Rooms

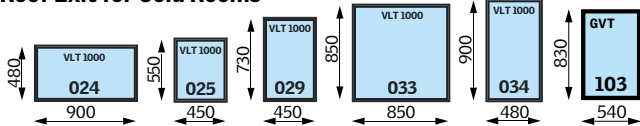

Flat Roof Windows

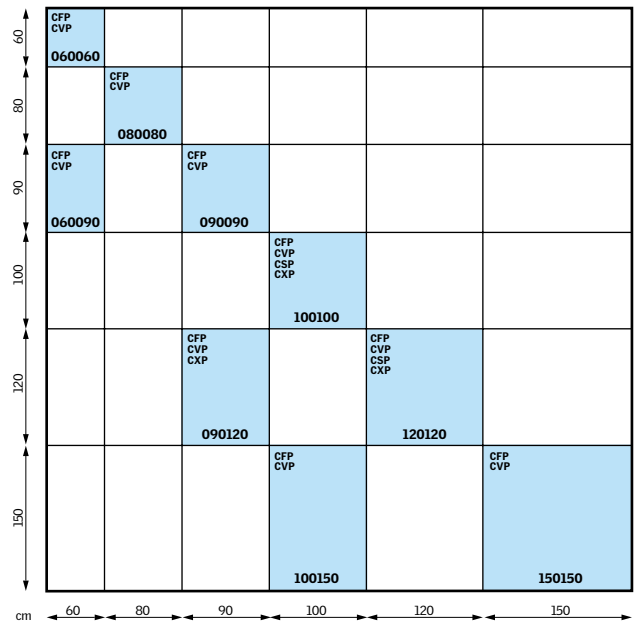

Roof Balcony CABRIO®

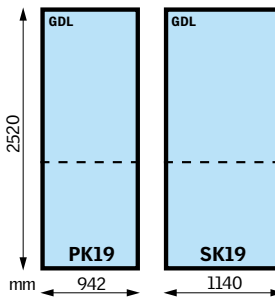

Sun Tunnels

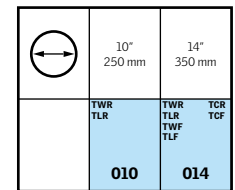

Place the roof window in the ideal location

How high will the roof window be installed? The answer to this question depends of several factors, but in general there are 3 rules that must be observed, as shown in the figure.

Rule 1: The top of the roof window should be placed in a way that the operating bar stays approximately 200 cm above ground level, making it easy to access and handle.

Rule 2: The bottom of the roof window should be placed about 90 cm above floor level to allow a good view to the outside, both standing and sitting.

Rule 3: The length of the roof window depends in practical terms of the slope of the roof. The lower the slope, the longer the roof window should be, going as much as possible towards rule 1 and 2.

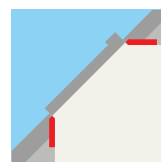
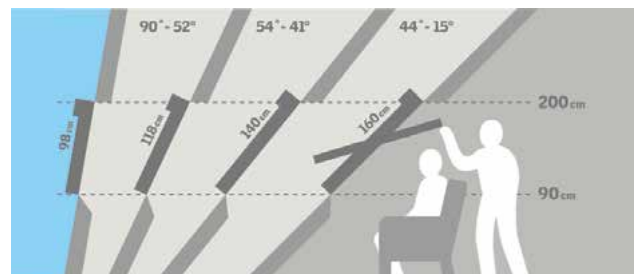

Interior coating

The sloped wall covering should be made with an horizontal cut at the top and vertical at the bottom, as exemplified in the figure. This will allow greater light input, better access/ approach to the roof window and, when a heater is placed under the roof window, helps to reduce condensation

Glazing comparison guide

VELUX glazing provides heat insulation, sound insulation, adds strength, safety and protection from the elements. The guide below helps you select the right glazing for your project.

VELUX recommends that you consider using glazing units with laminated glass on the inside for roof windows placed above areas where people sleep, play or work.

Glazing options		Non-Laminated --50	Standard --70	Sun Protection --76	Top Quality --60
Composition	Inner Glass Spacing Outer Glass	4 mm 16 mm Argon 4 mm Toughened	33.2 Laminated 15 mm Argon 4 mm Toughened	33.1 Laminated 15 mm Argon 4 mm Toughened	33.2 Laminated 15 mm Argon 6 mm Toughened
Thermal transmittance U_w (norm EN ISO 12567-2)		1,3	1,3	1,3	1,3
Total solar energy transmittance g (Norm EN 410)		0,46	0,46	0,31	0,63
Sound insulation [dB] R_w (Norm ISO 717-1)		32	35	35	37
 Heat insulation Low-energy glazing units provide reduced heat loss through the window and enhance indoor comfort.		●	●	●●	●●
 Solar gain In the wintertime, the heat from the sun that enters the building through windows is a usable solar gain.		●●●	●●●	●	●
 Sun protection In warm climates and rooms with big roof windows, the sun protection offers a better indoor climate during summer time.				●●●	
 Sound insulation A combination of laminated glass and optimal glass thickness provides better sound insulation. Frame, sash constructions and gaskets are equally important.		●	●●	●●	●●●
 Safety Thicker laminated inner glass specially designed to increase resistance against a manual attack (burglary).			●		●
 Energy balance The energy balance represents the ability of the roof window to utilize the passive solar gain and keep the heat during winter as well as its ability to protect against overheating during summer.		✓	✓	✓	✓
 Protection Inner laminated glass ensures personal safety. It is designed to hold the fragments together if the glass shatters.			✓	✓	✓
 Outside strength Toughened outer glass makes your glazing unit more resistant to hail, heavy wind and snow loads.		✓	✓	✓	✓
 Delayed fading of materials Laminated inner glass protects materials behind it against UV rays therefore delaying the process of fading materials.			✓	✓	✓
 Rain noise reduction The combination of laminated glass and extra thick glass helps to provide a significant audible reduction of rainfall. Frame, sash constructions and gaskets are equally important.					✓
 Easy-to-clean The easy-to-clean coating minimizes the cleaning frequency of the outer glass and gives you a clearer view in case of rain or dew on the outer glass.					✓
 Anti-dew The anti-dew coating reduces significantly the outside dew allowing you to keep a clear view.					✓

● Good ●● Better ●●● Best ✓ Feature included in glazing type

Manual roof windows for pitched roofs

GGL, GGU, GPL, GPU, GZL, GZL B, GTL



GGL

Top-operated roof window (centre-pivot), allows you to rotate it 180 degrees to clean the exterior glass, finishes available as white painted or clear varnish pine wood. The elegant control bar, placed at the top of the roof window, is used to operate the roof window as well as to allow ventilation when closed. For roof pitch between 15–90 degrees.



GGU

It has the same characteristics as the GGL model, but with a finish in white polyurethane with wooden core. It's the perfect choice for high-humidity rooms or to create a different and modern style. For roof pitch between 15–90 degrees.



A maintenance-free variant featuring a core of thermo-modified wood with a seamless, waterproof polyurethane coating.



GPL

Bottom-operated (top-hung) roof window, finishes available as white painted or clear varnish pine wood, it has a double opening system: outwards, with an opening up to 45 degrees, and tilting, allowing to rotate the roof window at 180 degrees for cleaning the exterior glass. Ventilation with the roof window closed it's possible. It should not be installed in an out of reach position. For roof pitch between 15–55 degrees.



GPU

It has the same characteristics as GPL, but with a finish in white polyurethane with wooden core. The 45 degree opening creates a sensation of space allowing you to take pleasure of a uninterrupted panoramic view. For roof pitch between 15–55 degrees.



GTL

Ideal for emergency situations where quick access to the outside is required. The roof window opens using the frame bottom handle, projects at a 45 degree angle, however in emergency situation it pushes a little further and it projects at an angle of 67 degrees. For roof pitch between 15–55 degrees.



Exit RW	Sizes in cm	
	78x140	114x140
Window models	MK08	SK08
GTL 3070	✓	✓
GTL 3060	✓	✓
GTU 0050	✓	✓
GTU 0070	✓	✓
GTU 0060	✓	✓



GZL – Top operated

Top-operated center-pivot roof windows make it possible to place furniture directly below the window without obstructing operation of the window. Perfect for knee walls between 80 up to 130 cm. Available in clear lacquered pine wood and with Standard low energy glazing 51. Only possible to open by inserting the hand below/ underneath the top control bar. Integrated ventilation in the top control bar. It allows you to rotate it 180 degrees to clean the exterior glass. For roof pitch between 15–90 degrees.



GZL – Bottom Operated

Recommended for knee walls between 130 up to 150 cm. It's only available as manual operated. Available in clear lacquered pine wood and with Standard low energy glazing 51. Only possible to open by the bottom handle installed in the sash. Comes with an efficient ventilation slot in the top of the sash. It allows you to rotate it 180 degrees to clean the exterior glass. For roof pitch between 15–90 degrees.

Roof Windows	55x78	55x98	55x118	66x98	66x118	66x140	78x98	78x118	78x140	78x160	94x55	94x98	94x118	94x140	94x160	114x118	114x140	114x160	134x98	134x140	134x160
Sizes in cm Window models	CK02	CK04	CK06	FK04	FK06	FK08	MK04	MK06	MK08	MK10	PK25	PK04	PK06	PK08	PK10	SK06	SK08	SK10	UK04	UK08	UK10
Pine wood with clear varnish OR Pine wood white painted:																					
GGL 3050 or 2050 (Non-Laminated)	✓	✓	✓	✓	✓	✓	✓	✓	✓	✓	✓	✓	✓	✓	✓	✓	✓	✓	✓	✓	✓
GGL 3070 or 2070 (Standard)	✓	✓	-	✓	✓	✓	✓	✓	✓	✓	✓	✓	✓	✓	✓	✓	✓	✓	✓	✓	✓
GGL 3076 or 2076 (Sun Protection)	✓	✓	-	-	✓	-	✓	✓	✓	-	-	-	-	-	✓	✓	✓	-	✓	✓	-
GGL 3060 or 2060 (Top quality)	✓	✓	✓	✓	✓	✓	✓	✓	✓	✓	✓	-	✓	✓	✓	✓	✓	✓	✓	✓	✓
GPL 3050 or 2050	-	✓	✓	-	✓	✓	✓	✓	✓	✓	-	-	✓	✓	✓	✓	✓	✓	-	✓	-
GPL 3070 or 2070	-	✓	✓	-	✓	✓	✓	✓	✓	✓	-	-	✓	✓	✓	✓	✓	✓	-	✓	-
GPL 3076 or 2076	-	✓	-	-	-	-	✓	✓	✓	-	-	-	-	-	-	✓	✓	-	-	✓	-
GPL 3060 or 2060	-	✓	✓	-	✓	✓	✓	✓	✓	✓	-	-	✓	✓	✓	✓	✓	✓	-	✓	-
White polyurethane with wooden core:																					
GGU 0050	✓	✓	✓	✓	✓	✓	✓	✓	✓	✓	-	-	✓	✓	✓	✓	✓	-	✓	✓	-
GGU 0070	✓	✓	✓	✓	✓	✓	✓	✓	✓	✓	-	-	✓	✓	✓	✓	✓	-	✓	✓	-
GGU 0076	✓	✓	-	-	✓	-	✓	✓	✓	-	-	-	-	✓	-	✓	✓	-	✓	✓	-
GGU 0060	✓	✓	✓	✓	✓	✓	✓	✓	✓	✓	-	-	✓	✓	✓	✓	✓	-	✓	✓	-
GPU 0050	-	✓	✓	-	✓	✓	✓	✓	✓	✓	-	-	✓	✓	✓	✓	✓	✓	-	✓	-
GPU 0070	-	✓	✓	-	✓	✓	✓	✓	✓	✓	-	-	✓	✓	✓	✓	✓	✓	-	✓	-
GPU 0076	-	✓	-	-	-	-	✓	✓	✓	-	-	-	-	✓	-	✓	✓	-	-	✓	-
GPU 0060	-	✓	✓	-	✓	✓	✓	✓	✓	✓	-	-	✓	✓	✓	✓	✓	-	-	✓	-
GZL 1051	✓	✓	-	✓	✓	✓	✓	✓	✓	✓	-	-	✓	✓	-	✓	✓	-	-	-	-
GZL 1051B	-	-	-	-	✓	-	✓	✓	✓	✓	-	-	-	✓	-	-	-	-	-	-	-

Motorized roof windows for pitched roofs

GGL/GGU INTEGRA, GGL/GGU SOLAR



GGL/GGU INTEGRA

The INTEGRA roof window comes with all the electrical components already installed. Includes the pre-paired wall switch remote control KLI 311 and rain sensor, which closes automatically when it starts to rain. Equipped with radio frequency technology based on the io-homecontrol® platform.



GGL/GGU SOLAR

The world's first solar powered roof window! With integrated motor that operates with the energy of the sun. Includes rain sensor and the pre-paired wall switch remote control KLI 311. Without need to pass any wires to your installation which makes this the ideal roof window for new construction and replacement of old roof windows.

Note: The installation of a solar awning blind requires the ZOZ 213K adapter when installed on a solar roof window or on a roof window using a conversion solar KIT (see page 27).



For better utilize your electric roof windows, VELUX recommends the VELUX ACTIVE.



Are you ready for an automatic healthier home?

VELUX ACTIVE with NETATMO makes it easier to improve the indoor climate. The sensors measure the temperature, CO₂ level and humidity and operates your VELUX INTEGRA® products. You can also operate your products VELUX INTEGRA® from any location with the VELUX ACTIVE application.

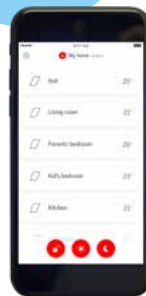

Roof Windows	55x78	55x98	55x118	66x98	66x118	66x140	78x98	78x118	78x140	78x160	94x55	94x98	94x118	94x140	94x160	114x118	114x140	114x160	134x98	134x140	134x160	
Sizes in cm	CK02	CK04	CK06	FK04	FK06	FK08	MK04	MK06	MK08	MK10	PK25	PK04	PK06	PK08	PK10	SK06	SK08	SK10	UK04	UK08	UK10	
Window models	Pine wood with clear varnish OR Pine wood white painted:																					
GGL INTEGRA® 3070 or 2070	✓	✓	✓	✓	✓	✓	✓	✓	✓	✓	✓	✓	✓	✓	✓	✓	✓	✓	✓	✓	✓	✓
GGL INTEGRA® 3060 or 2060	✓	✓	✓	✓	✓	✓	✓	✓	✓	✓	-	-	✓	✓	✓	✓	✓	✓	✓	✓	✓	✓
GGL Solar® 3070 or 2070	✓	✓	✓	✓	✓	✓	✓	✓	✓	✓	✓	✓	✓	✓	✓	✓	✓	-	✓	✓	-	-
GGL Solar® 3060 or 2060	✓	✓	✓	✓	✓	✓	✓	✓	✓	✓	-	-	✓	✓	✓	✓	✓	✓	✓	✓	✓	✓
White polyurethane with wooden core:																						
GGU INTEGRA® 0070	✓	✓	✓	✓	✓	✓	✓	✓	✓	✓	-	-	✓	✓	✓	✓	✓	-	✓	✓	-	-
GGU INTEGRA® 0076	✓	✓	-	-	-	-	✓	✓	✓	-	-	-	-	-	-	✓	✓	-	✓	✓	-	-
GGU INTEGRA® 0060	✓	✓	✓	✓	✓	✓	✓	✓	✓	✓	-	-	✓	✓	✓	✓	✓	-	✓	✓	-	-
GGU Solar 0070	✓	✓	✓	✓	✓	✓	✓	✓	✓	✓	-	-	✓	✓	✓	✓	✓	-	✓	✓	-	-
GGU Solar 0060	✓	✓	✓	✓	✓	✓	✓	✓	✓	✓	-	-	✓	✓	✓	✓	✓	-	✓	✓	-	-

Roof Balcony CABRIO®

GDL

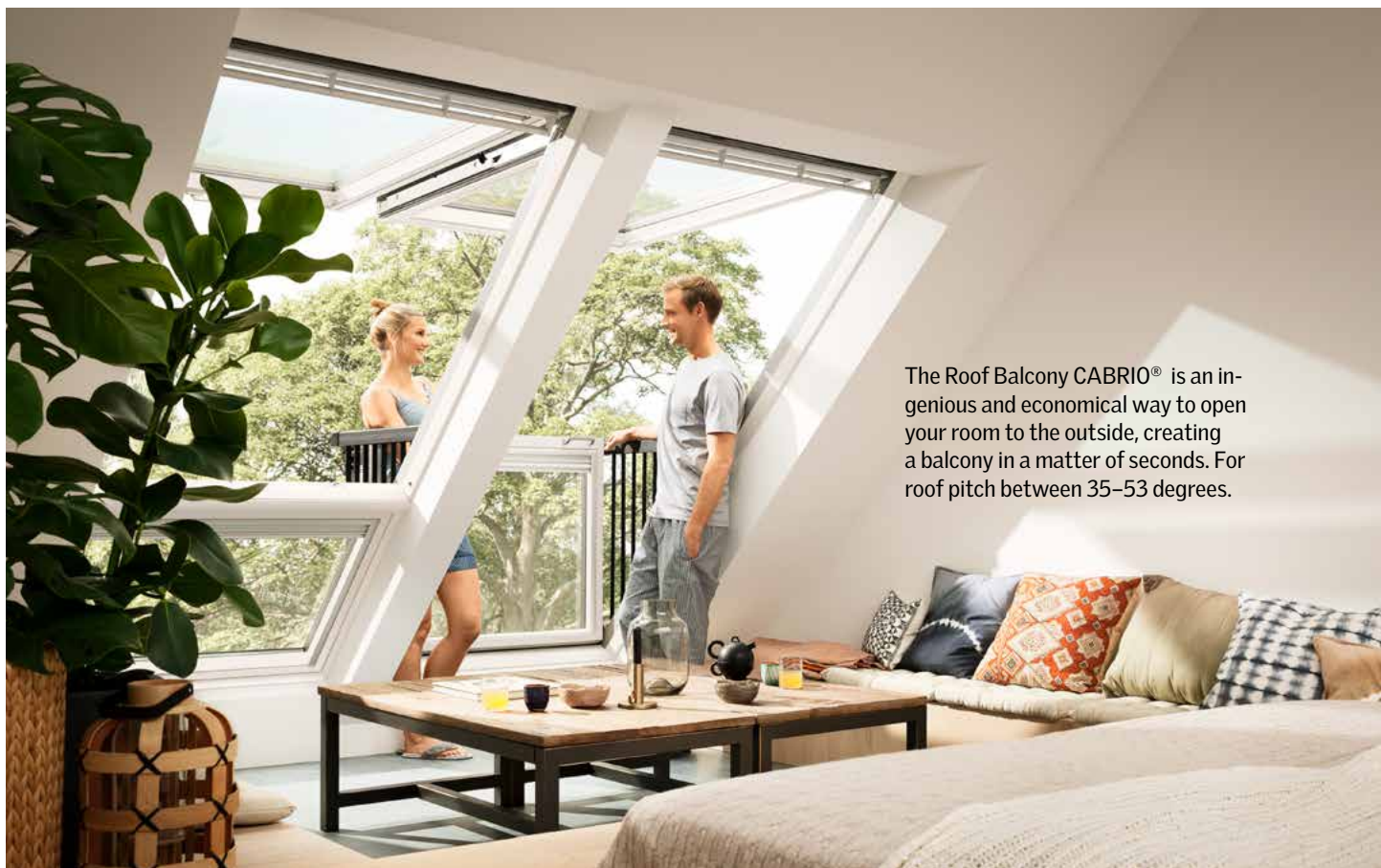

The Roof Balcony CABRIO® is an ingenious and economical way to open your room to the outside, creating a balcony in a matter of seconds. For roof pitch between 35–53 degrees.

Roof Balcony - Cabrio	Sizes in cm Window models	94x252 PK19	114x252 SK19
Pine wood with clear varnish OR Pine wood white painted:			
GDL PK19 3066 or 2066		✓	-
GDL SK19 3066 or 2066		-	✓
Flashings for Roof Balcony – Cabrio			
EDW – For profiled roofing material up to 120 mm		✓	✓
EDS – For flat roofing material up to 8 mm – w/ side sections		✓	✓
EDL – For flat roofing material up to 8 mm – w/ side soakers		✓	✓

Facade element

VFE



Ideal for mansard roofs, the VFE facade element combined with VELUX roof windows give you a floor to ceiling opening to the outside. The result is a fantastic view of the world below and a wall of light inside

your home. With a top handle it opens inwards, can be secured in ventilation position with sash approximately 155 mm open. For roof pitch between 15–55 degrees.

Roof Windows	Sizes in cm Window models	78x60 MK31	78x95 MK35	94x60 PK31	94x95 PK35	114x60 SK31	114x95 SK35	134x60 UK31	134x95 UK35
Pine wood with clear varnish OR Pine wood white painted:									
VFE 3070 or 2070		✓	✓	✓	✓	✓	✓	✓	✓

Roof Windows and exits for uninhabited rooms

Roof exit GVT



Exit to the outside for uninhabited rooms. With GVT going outside to the roof for small arrangements is no longer a problem. This roof window opens like a door and comes complete with insulating glass

unit, opening restrictor and integrated flashing allowing a more convenient and quick installation. Optional right or left side-hung function For roofs pitch between 20–65 degrees.

Roof Exits for cold rooms	Sizes in cm	54x83
Window models		103
Pine wood with Polyurethane coating:		
GVT 103 (w/ flashing)		✓

Roof exit VLT



VELTA roof exit window allows in an economical way the entrance of light and ventilation in the uninhabited attics! In situations where attics are used for housing purposes, VELUX roof windows are always the most appropriate solution. The frame is made of pine wood with an exte-

rior metal-cladding and the sash is made of aluminum. Comes with insulating glass unit and integrated flashing. It exists in 5 different sizes. For roof pitch between 20–60 degrees (sizes 025, 029 and 034) and 20–45 degrees (sizes 024 and 033).

Roof Exits for cold rooms	90x48	45x55	45x73	85x85	48x90
Window models	024	025	029	033	034
Pine wood with clear varnish:					
VLT 1000 (w/ flashing)	✓	✓	✓	✓	✓

VELUX Roof Pitch

You don't know what is the slope of your roof? VELUX gives you a hand. Download our application to measure the angle of your roof. Available for iOS and Android.



MyDaylight

An application that allows you to design your room by selecting parameters such as room dimensions, ceiling height and slope, placing VELUX roof windows and then visualizing the actual effect of natural light input in a 360° environment and with realistic virtual options.





Installation products

For a better insulation

The installation of VELUX roof windows is based on a process that ensures a waterproof and durable finish. For perfect installation, we recommend using VELUX original installation products.

VELUX installation products are custom-made for our roof windows and designed to fit perfectly, making installation easy, fast, reliable and durable. All steps were considered to make the installation faster, easier and more logical for the installer.

100 % waterproof

VELUX flashings and installation products make the installation of your VELUX roof windows simple, quick and ensure the watertightness of your roof window.

Complete system

By using the BDX insulation frame and the BFX underfelt collar in combination with the flashing, you will have a more complete solution in the waterproofing of your VELUX roof window.

Roof integration

Our roof windows were designed to integrate itself into your roof – installation products do not alter this feature. All VELUX installation products were designed to be perfectly integrated in the installation of a VELUX roof window. The result is a solid installation that will last for many years.

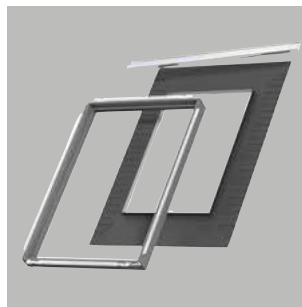

BFX 1000

Kit composed by two installation products: Underfelt collar and a water drainage gutter. Together it ensures a watertight seal between the roof window and the roofing material. The underfelt collar is pleated which allows its installation on concrete and wooden roofing material. The water drainage gutter leads the water to the sides and also helps to create a watertight seal between the roof window and the underfelt collar.

BDX 2000

KIT composed by three installation products: insulation frame, underfelt collar and a water drainage gutter. Together these products seal and insulate the window from the outside. The insulation frame is composed by a galvanized steel frame and flex foam that provides a tight and secure fit between the roof window and the roof construction. Optimizing an even more energy efficiency and durable installation.

Note: The insulation frame needs a larger opening - you should leave the window measurement + approximately 5 cm. For situations where it's not possible to install the insulation frame and you nevertheless want to use installation products, you should opt for the BFX 1000.

Installation Material	Sizes in cm	55x78	55x98	55x118	66x98	66x118	66x140	78x98	78x118	78x140	78x160	94x98	94x118	94x140	94x160	114x118	114x140	114x160	134x98	134x140	134x160
Window models		CK02	CK04	CK06	FK04	FK06	FK08	MK04	MK06	MK08	MK10	PK04	PK06	PK08	PK10	SK06	SK08	SK10	UK04	UK08	UK10
Flashings for roof windows installation in groups:																					
BDX 2000 - Insulation frame + underfelt collar		✓	✓	✓	✓	✓	✓	✓	✓	✓	✓	✓	✓	✓	✓	✓	✓	✓	✓	✓	✓
BFX 1000 - Underfelt collar		✓	✓	✓	✓	✓	✓	✓	✓	✓	✓	✓	✓	✓	✓	✓	✓	✓	✓	✓	✓
EDW 2000 - Flashing + BDX set		✓	✓	✓	✓	✓	✓	✓	✓	✓	✓	✓	✓	✓	✓	✓	✓	✓	✓	✓	✓

Accessories that are compatible with the new generation VELUX roof windows and the previous generation (generation without K in the reference ex: M04)

Roof opening size

Installation WITH BDX insulation frame

For an installation with the insulation frame BDX 2000 you need an opening with:

- Window width plus 5 cm
- Window height plus 5 cm

For example, a roof window size 78x98 cm needs an opening of 83x103 cm

Installation WITHOUT BDX insulation frame

For an installation without the insulation frame BDX 2000 you need an opening with:

- Window width plus 2 cm
- Window height plus 2 cm

For example, a roof window size 78x98 cm needs an opening of 80x100 cm



In both cases it's always necessary an entire row of tiles under the roof window. The distance from the top of the tile to the bottom rim of the roof window must have 10 cm.

Flashings for single installation

EDW, EDL, EDS



EDW

Flashing for installation of a roof window with a high-profiled roofing material up to 120 mm.



15°-90°



EDL

Flashing for installation of a roof window in a flat roofing material up to 8 mm (with side soakers)



15°-90°



EDS

Flashing for installation of a roof window in a flat roofing material up to 8 mm (side sections)



Flex foam: EDW flashing comes with a flexible foam that ensures a natural connection of the flashing with the tile for a more effective, faster and higher quality.

Installation in cement roofing: VELUX provides brackets for the installation of your roof windows in this type of roofing material. The EDW and EDL flashing with the end reference **S** will be supplied with this brackets.

Installation Material	Sizes in cm	55x78	55x98	55x118	66x98	66x118	66x140	78x98	78x118	78x140	78x160	94x55	94x98	94x118	94x140	94x160	114x118	114x140	114x160	134x98	134x140	134x160	
Window models		CK02	CK04	CK06	FK04	FK06	FK08	MK04	MK06	MK08	MK10	PK25	PK04	PK06	PK08	PK10	SK06	SK08	SK10	UK04	UK08	UK10	
Flashings for installation of single roof windows:																							
EDW	For profiled roofing material up to 120 mm	✓	✓	✓	✓	✓	✓	✓	✓	✓	✓	✓	✓	✓	✓	✓	✓	✓	✓	✓	✓	✓	✓
EDW-S	For profiled roofing material up to 120 mm - w/ brackets	✓	✓	✓	✓	✓	✓	✓	✓	✓	✓	✓	✓	✓	✓	✓	✓	✓	✓	✓	✓	✓	✓
EDS	For profiled roofing material up to 8 mm - w/ side sections	✓	✓	✓	✓	✓	✓	✓	✓	✓	✓	-	-	✓	✓	✓	✓	✓	✓	✓	✓	✓	✓
EDL	For profiled roofing material up to 8 mm - w/ side soakers	✓	✓	✓	✓	✓	✓	✓	✓	✓	✓	-	✓	✓	✓	✓	✓	✓	✓	✓	✓	✓	✓
EDL-S	For profiled roofing material up to 8 mm - w/ side soakers	✓	✓	✓	✓	✓	✓	✓	✓	✓	-	✓	✓	✓	-	✓	✓	✓	-	✓	✓	✓	✓

Kerb for installation in flat roofs

ECX



Now you can install a roof window in our kerb. Our flat roof kerb allows you the flexibility to select the most appropriate type of roof window for your installation such as GGL or VELUX INTEGRA electric or solar powered. The kerb is angled at 19°, allowing rain and dirt to drain away. You will be able to install blinds to suit your needs. For your safety, VELUX always recommends the installation of a roof window with laminated glass in this solution.

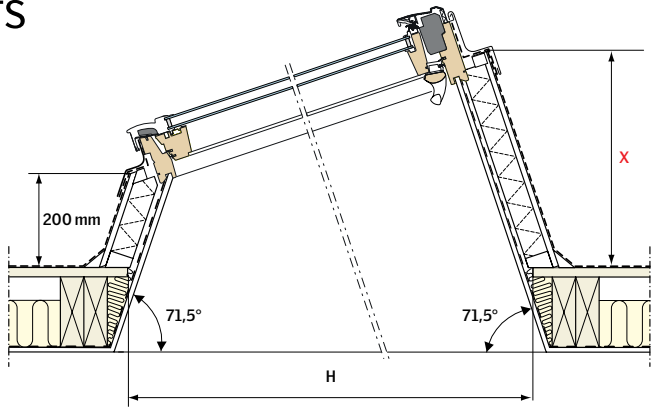

Cut and Opening

Window models	Sizes in cm (WxH)	W mm	H mm	X mm
CK02	55 x 78	600	1000	490
CK04	55 x 98	600	1200	550
MK04	78 x 98	800	1200	550
MK06	78 x 118	800	1400	610
MK08	78 x 140	800	1650	680
PK04	94 x 98	950	1200	550
SK06	114 x 118	1150	1400	610
UK08	134 x 140	1350	1650	680

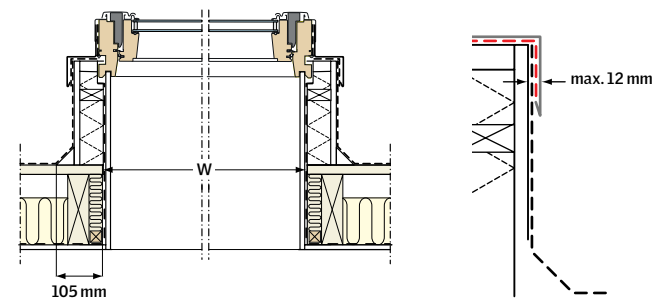

Flat Roof Kerb	External window frame size in cm	55x78	55x98	78x98	78x118	78x140	94x98	114x118	134x140
Window models		CK02	CK04	MK04	MK06	MK08	PK04	SK06	UK08
Flashings for installation of single roof windows:									
ECX 000T		✓	✓	✓	✓	✓	✓	✓	✓

Combi flashings

EKW, EKS & EKL



Combined installation

The combi system consists of 7 basic elements which allows you to group roof windows in various ways.

The roof windows grouped side by side must have the same height. The roof windows grouped one above the other must have the same width.

See the examples beside:

EKW 0021	Left element + right (0001+0003)	
EKW 0001	Left element	
EKW 0002	Lower middle element	
EKW 0003	Right element	
EKW 0004	Upper left element	
EKX 0005	Upper middle element	
EKW 0006	Upper right element	
EKW 0007	Top elements for overlapping windows	

The VELUX flashings guarantee an easy installation in any roof with a pitch roof between 15-90 degrees.

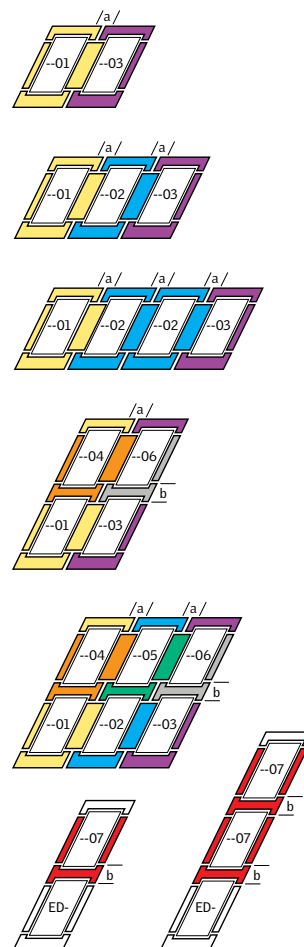

EKW, EKS & EKL

The standard distance between the window frames is 10 cm. If you wish to install external blinds on the roof windows (either at the time of installation of the roof window, or in the future), it's necessary that the distance between overlapping windows (one above the other, in other words, distance "b") to have 25 cm.



Installation Material	55x78	55x98	55x118	66x98	66x118	66x140	78x98	78x118	78x140	78x160	94x98	94x118	94x140	94x160	114x118	114x140	114x160	134x98	134x140	134x160
Window models	CK02	CK04	CK06	FK04	FK06	FK08	MK04	MK06	MK08	MK10	PK04	PK06	PK08	PK10	SK06	SK08	SK10	UK04	UK08	UK10
Flashings for roof windows installation in groups:																				
EKW 0021	For profiled roofing material up to 120 mm - Side by side	✓	✓	✓	✓	✓	✓	✓	✓	✓	✓	✓	✓	✓	✓	✓	✓	✓	✓	✓
EKS 0021	For profiled roofing material up to 8 mm - w/ side sections - Side by side	✓	✓	✓	✓	✓	✓	✓	✓	✓	-	✓	✓	✓	✓	✓	✓	✓	✓	✓
EKL 0021	For profiled roofing material up to 8 mm - w/ side soakers - Side by side	✓	✓	✓	✓	✓	✓	✓	✓	✓	✓	✓	✓	✓	✓	✓	✓	✓	✓	✓

Sunscreening

How to choose the right blind

1 Take note of the reference of your VELUX roof window

 The reference of your roof window is the guarantee to get the right accessory. In case of doubt contact VELUX-INT (VELUX A/S).

New Generation

The new generation roof windows are distinguished by the introduction of the letter **K** in the size code. The accessories references for these roof windows must also have the letter **K** in the code. These blinds are only compatible with the New Generation of VELUX roof windows.

The data plate of these roof windows is located in the **upper left corner**, behind the ventilation flap.



Previous Generations

See below the data plates of these roof windows and how you can obtain the reference of them to acquire your blinds.

The data plate of these roof windows is located in the **upper right corner**, behind the ventilation flap.



2 Define your needs and choose one of the indicated products

I want protection against heat, noise, dimming and safety in just one product	Exterior Roller Shutter
I want to control the heat in the room	Energy blind Exterior awning blind Exterior roller shutter
I want to block the incoming light in the room	Blackout blind Energy blind Exterior roller shutter
I want to adjust and control the sunlight in the room	Venetian blind Roller blind Pleated blind Roman blind
I want to add protection against insect entry	Insect screen Once the insect screen is installed on the wall, you can still install interior blinds and exterior protection.

3 Choose the suncreening operation



Manually operated



Electrically operated



Solar operated

All VELUX electrical and solar powered accessories operate with a io-homecontrol® platform. For more information about this system, please consult the respective page at the website.

 io-homecontrol® provides advanced and secure radio technology that is easy to install. io-homecontrol® labelled products communicate with each other, improving comfort, security and energy savings. www.io-homecontrol.com

4 Select the color of your blind



Note: there may be some differences between the color samples presented in this catalog and the real material.

New information  Fabrics transparency: Some fabrics pass more light than others. Use the scale on the side to help you choose the level of transparency you want.

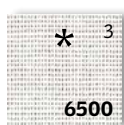

You will find this scale in the upper right corner of the color.

- 1 Transparent
- 2 Semitransparent
- 3 Opaque
- 4 Light reduction
- 5 Blackout

5 Install the product

Pick & Click![®]

A VELUX exclusive!

VELUX roof windows are fitted with pre-installed brackets to ease installation and to ensure a perfect fit every time.



Enjoy your new blind and create the perfect environment at your home!



All VELUX internal blinds are power operated or cordless operated and fulfil the safety in use requirements in EN 13120:2009+A1:2014 and EN 60335-2-97:2006+EN 60335-2-97:2006/A12:2015.

Blackout blinds



In need of darkness this is the indicated blind. The face to the outside of this blind is covered with a reflective film, whereby the darkness is possible with any color. It runs on side rails, allowing its positioning adjustable.



The 2 in 1 blackout blind (DFD) is the combination of a blackout blind and a pleated blind available in all colors for the blackout blind with the pleated blind always in white color.

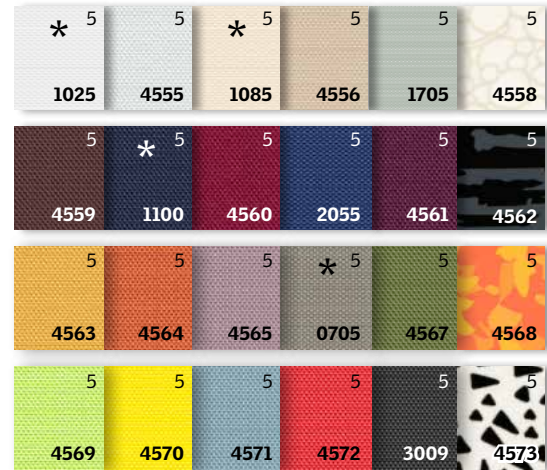

* Standard colors: 1025, 1085, 1100, 0705

Blackout Blind	CK02	CK04	CK06	FK04	FK06	FK08	MK04	MK06	MK08	MK10	PK04	PK06	PK08	PK10	SK06	SK08	SK10	UK04	UK08	UK10
DKL manual	✓	✓	✓	✓	✓	✓	✓	✓	✓	✓	✓	✓	✓	✓	✓	✓	✓	✓	✓	✓
DML electric	✓	✓	✓	✓	✓	✓	✓	✓	✓	✓	✓	✓	✓	✓	✓	✓	✓	✓	✓	✓
DSL solar	✓	✓	✓	✓	✓	✓	✓	✓	✓	✓	✓	✓	✓	✓	✓	✓	✓	✓	✓	✓
DFD manual combination of blackout blind & pleated blind	✓	✓	✓	✓	✓	✓	✓	✓	✓	✓	✓	✓	✓	✓	✓	✓	✓	✓	✓	✓

For roof windows with other references, please contact VELUX-INT (VELUX A/S).
The electric blind needs to be connected to a control unit KUX 110 (see page 26).





Pleated blind



The pleated blind is now a blind that installs itself. It allows you to control the desired light intensity as well as to obtain a stylish and practical decorative solution. It runs on side rails and can be placed in any position of the roof window, since it's not attached at the top or bottom (manual version only).

Note: Combine your pleated blinds with exterior awnings blinds or roller shutters for additional protection and comfort.

* Standard Colors: 1016, 1258, 1259



Pleated Blinds	CK02	CK04	CK06	FK04	FK06	FK08	MK04	MK06	MK08	MK10	PK04	PK06	PK08	PK10	SK06	SK08	SK10	UK04	UK08	UK10
FHL manual	✓	✓	✓	✓	✓	✓	✓	✓	✓	✓	✓	✓	✓	✓	✓	✓	✓	✓	✓	✓
FML electric	✓	✓	✓	✓	✓	✓	✓	✓	✓	✓	✓	✓	✓	✓	✓	✓	✓	✓	✓	✓

New Model!

For roof windows with other references, please contact VELUX-INT (VELUX A/S). The electric blind needs to be connected to a control unit KUX 110 (see page 26).

Roman blind



Get ready to enjoy a wide range of decorative solutions with our Roman blinds. Explore the full potential of stylish fabrics and breathe in the soft effects that make this collection refined and original. The fabric can be easily changed in a matter of minutes due to the unique construction of the Roman blind. You just have to choose the pattern! There are fabrics that let out more light than others. The fabrics are sold separately for a flexibility in the decoration without limits. Choose from the twenty contemporary standards that VELUX has to offer you.

* Standard colors: 6500, 6503, 6510, 6513



Roman blind	CK02	CK04	CK06	FK04	FK06	FK08	MK04	MK06	MK08	MK10	PK04	PK06	PK08	PK10	SK06	SK08	SK10	UK04	UK08	UK10
FHB manual	✓	✓	✓	✓	✓	✓	✓	✓	✓	✓	✓	✓	✓	✓	✓	✓	✓	✓	✓	✓
ZHB blind fabric for exchange	✓	✓	✓	✓	✓	✓	✓	✓	✓	✓	✓	✓	✓	✓	✓	✓	✓	✓	✓	✓

For roof windows with other references, please contact VELUX-INT (VELUX A/S).



Roller blind



A simple, stylish way to soften incoming light, offering privacy and basic light protection. The RHL model works with hooks and only exists in standard colors. The other models run on side rails, allowing them to be placed in any position, exists in standard and special colors.

* Standard colors: 1028, 1086, 4000, 9050

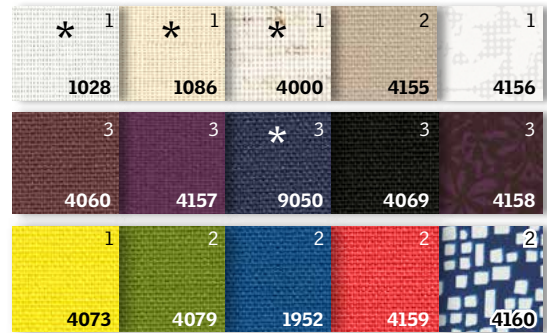

Roller blind	CK02	CK04	CK06	FK04	FK06	FK08	MK04	MK06	MK08	MK10	PK04	PK06	PK08	PK10	SK06	SK08	SK10	UK04	UK08	UK10
RFL manual	✓	✓	✓	✓	✓	✓	✓	✓	✓	✓	✓	✓	✓	✓	✓	✓	✓	✓	✓	✓
RML electric	✓	✓	✓	✓	✓	✓	✓	✓	✓	✓	✓	✓	✓	✓	✓	✓	✓	✓	✓	✓
RSL solar	✓	✓	✓	✓	✓	✓	✓	✓	✓	✓	✓	✓	✓	✓	✓	✓	✓	✓	✓	✓
RHL manual with hooks	✓	✓	✓	✓	✓	✓	✓	✓	✓	✓	✓	✓	✓	✓	✓	✓	✓	✓	✓	✓

For roof windows with other references, please contact VELUX-INT (VELUX A/S). The electric blind needs to be connected to a control unit KUX 110 (see page 26).



Pleated energy blind



The pleated energy blind provides blackout and an insulation effect up to 21% (the technical values comply with EN ISO 12567-2, EN 13363-2 and ISO 15099) – the effect depends of roof window type and pane. The double-pleated blackout fabric doesn't let light pass through and has an aluminum honeycomb structure within to improve insulation.

* Standard Color: 1045



Pleated energy blind	CK02	CK04	CK06	FK04	FK06	FK08	MK04	MK06	MK08	MK10	PK04	PK06	PK08	PK10	SK06	SK08	SK10	UK04	UK08	UK10
FHC manual	✓	✓	✓	✓	✓	✓	✓	✓	✓	✓	✓	✓	✓	✓	✓	✓	✓	✓	✓	✓

For roof windows with other references, please contact VELUX-INT (VELUX A/S). The electric blind needs to be connected to a control unit KUX 110 (see page 26). The electric and solar blinds don't make full blackout effect.



Venetian blind



It regulates the intensity and direction of light. The slats remain in perfect condition thanks to the side rails. Their unique cordless design eliminates unsightly hanging cords and allow you to easily tilt the slats in any direction.

It has a low-maintenance and is resistant to humidity, therefore the perfect solution for bathrooms and kitchens.

* Standard color: 7001

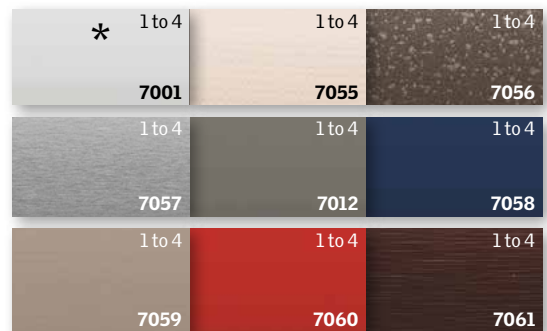

Venetian blind	CK02	CK04	CK06	FK04	FK06	FK08	MK04	MK06	MK08	MK10	PK04	PK06	PK08	PK10	SK06	SK08	SK10	UK04	UK08	UK10
PAL manual	✓	✓	✓	✓	✓	✓	✓	✓	✓	✓	✓	✓	✓	✓	✓	✓	✓	✓	✓	✓

For roof windows with other references, please contact VELUX-INT (VELUX A/S).



Insect screen



It allows you to enjoy fresh air without the untimely presence of insects. Run over side rails and can be retracted when its use is not required. It's placed on the wall and not in the roof window itself, thus allowing installation of other interior decoration accessories. For maximum sizes please see the table below.

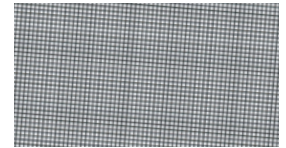

W (max.) mm RW aperture	H (max.) mm RW aperture	Insect Screen reference	For following RW sizes*
530	1600	ZIL CK02 8888	CK02
530	2000	ZIL CK06 8888	CK04 & CK06
640	2400	ZIL FK08 8888	FK04 & FK06 & FK08
760	2000	ZIL MK06 8888	MK04 & MK06
760	2400	ZIL MK10 8888	MK08 & MK10
922	2000	ZIL PK06 8888	PK04 & PK06
922	2400	ZIL PK10 8888	PK08 & PK10
1120	2000	ZIL SK06 8888	SK06
1120	2400	ZIL SK10 8888	SK08 & SK10
1285	1600	ZIL UK04 8888	UK04
1285	2400	ZIL UK10 8888	UK08 & UK10



Important: The sizes are an indication. You should always check the Width (W) and Height (H) of the roof window aperture and see which insect screen it's equal in size or its immediate superior size. The width of the insect screen can't be changed, but it can be adjusted in length since the side rails can be cut or joined to fit your aperture (maximum length of one rail: 1,20 m – for upper lengths, it's necessary to join rails).

Insect screen	CK02	CK04	CK06	FK04	FK06	FK08	MK04	MK06	MK08	MK10	PK04	PK06	PK08	PK10	SK06	SK08	SK10	UK04	UK08	UK10
ZIL manual	✓	✓	✓	✓	✓	✓	✓	✓	✓	✓	✓	✓	✓	✓	✓	✓	✓	✓	✓	✓

Kit exterior manual awning blind + manual blackout blind



A practical and effective combination to reduce heat and light control. All the benefits of a manual exterior awning (MHL) and a manual blackout blind (DKL) combined in a package at a reduced price (DOP).

Note: In this kit DKL is only available in white and beige colors.

More
economic
than
DKL + MHL

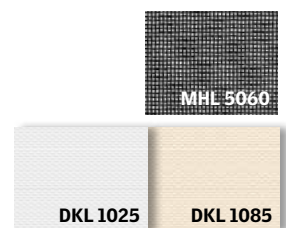

DOP	CK02	CK04	CK06	FK04	FK06	FK08	MK04	MK06	MK08	MK10	PK04	PK06	PK08	PK10	SK06	SK08	SK10	UK04	UK08	UK10
DOP DKL + MHL manual	✓	✓	✓	✓	✓	✓	✓	✓	✓	✓	✓	✓	✓	✓	✓	✓	✓	✓	✓	✓



Exterior sunscreening protection

Awning blinds

The exterior awning blind is made of a fabric net transparent allowing shading the house without however hide the outside view. Provides effective heat protection - reduces heat intake by up to 90 %. The manual awning blind is installed on the inside of the roof window (top), the electric and solar exterior awnings blinds are installed on the outside and can be installed in overlapping (one above the other) roof windows with 10 cm of distance.



MHL



The MHL is manually operated. It's fully maneuverable from the inside and it's discreetly pack up at the top of the roof window when not in use.

Note: Not possible to install the MHL on roof windows that are motorized at the top.



MML



The MML is operated with the pre-paired wall switch remote control KLI 313 (included). The installation is made outside the roof window. Connected directly to the INTEGRA roof window or to a control unit (sold separately – see page 26).



MSL



The MSL is installed in the roof window without the need for wires or carry out additional works. Operates on solar energy and it's controlled by the pre-paired wall switch remote control KLI 313 (included).

Note: To install the solar awning blind on a solar roof window or a roof window where a KSX 100K solar conversion kit is installed, you must purchase the adapter Z02 213K (see page 27).

Awning blinds	CK02	CK04	CK06	FK04	FK06	FK08	MK04	MK06	MK08	MK10	PK04	PK06	PK08	PK10	SK06	SK08	SK10	UK04	UK08	UK10
MHL manual	✓	✓	✓	✓	✓	✓	✓	✓	✓	✓	✓	✓	✓	✓	✓	✓	✓	✓	✓	✓
MML electric	✓	✓	✓	✓	✓	✓	✓	✓	✓	✓	✓	✓	✓	✓	✓	✓	✓	✓	✓	✓
MSL solar	✓	✓	✓	✓	✓	✓	✓	✓	✓	✓	✓	✓	✓	✓	✓	✓	✓	✓	✓	✓

Roller shutters

Offer extra security to your home. Made of hard-wearing aluminium to ensure top performance protecting effectively against extreme weather conditions and at the same time also providing sound reduction. When fully run, ensure the concealment of light. In overlapping (one above the other) roof windows the exterior roller shutters need a distance of 25 cm.

SHL



The SHL is operated manually which means that the roof window needs to be within reach. It can be raised and lowered completely by rotating the sash 180 degrees.

Note: The roof window can be open with the shutter closed.

SML



The SML is operated with the pre-paired wall switch remote control KLI 313 (included). The installation is made outside the roof window. Connected directly to the INTEGRA roof window or to a control unit (sold separately – see page 26).

SSL



The SSL is installed in the roof window without the need for wires or carry out additional works. It operates on solar energy and is controlled by the pre-paired wall switch remote control KLI 313 (included).

Note: To install the solar roller shutter on a solar roof window or a roof window where a KSX 100K solar conversion kit is installed, the size will need to be equal or superior to MK--.

Roller shutters	CK02	CK04	CK06	FK04	FK06	FK08	MK04	MK06	MK08	MK10	PK04	PK06	PK08	PK10	SK06	SK08	SK10	UK04	UK08	UK10
SHL manual	✓	✓	✓	✓	✓	✓	✓	✓	✓	✓	✓	✓	✓	✓	✓	✓	✓	✓	✓	✓
SML electric	✓	✓	✓	✓	✓	✓	✓	✓	✓	✓	✓	✓	✓	✓	✓	✓	✓	✓	✓	✓
SSL solar	✓	✓	✓	✓	✓	✓	✓	✓	✓	✓	✓	✓	✓	✓	✓	✓	✓	✓	✓	✓

Electric accessories

For a higher comfort

Transform a manual into an electric roof window

To transform your manual top-operated (centre-pivot) roof window into a solar roof window please use the below Kit. For new generation roof windows add **K** on the reference.



KSX 100K Solar conversion Kit

is a complete kit for converting VELUX manually top-operated (centre-pivot) roof windows GGL/GGU into a solar powered. Includes motor, rain sensor and a wall switch. It can only be installed in roof windows sizes equal or superior to -K04. It's not possible to connect any other product to this kit.

To transform your manual top-operated (centre-pivot) roof window into an electric roof window (connected to the mains) please use the 2 products below. For new generation roof windows add **K** on the reference.



KMG 100K

Motor that is placed discreetly behind the ventilation flap, getting hidden when the roof window is closed. Includes rain sensor and a wall switch. Requires to be connected to a control unit KUX 110.



KUX 110

Control unit. Consists of: Power supply unit with main cable and main plug with wall bracket for power supply.

Handle electric accessories

When installed in manual roof windows, electric blinds, electric roller shutters and electric awning blinds need to be connected to a control unit.



KUX 110

Control unit. Consists of: Power supply unit with main cable and main plug with wall bracket for power supply.

Do you have roof windows that are not New Generation?

If you have roof windows that are not New Generation you will have to choose from the following products:

KSX 100: Solar conversion kit for roof windows GGL/GGU

KMG 100: Motor for roof windows GGL/GGU

The remain electrical products are compatible with the previous VELUX roof windows.



io-homecontrol® provides advanced and secure radio technology that is easy to install. io-homecontrol® labelled products communicate with each other, improving comfort, security and energy savings.

www.io-homecontrol.com

Electric accessories

- KLI 311:** VELUX switch wall to operate 1 electrical or solar roof window, or several simultaneously
- KLI 312:** VELUX switch wall to operate 1 electrical or solar blind, or several simultaneously.
- KLI 313:** VELUX switch wall to operate 1 awning or roller shutter blind, or several simultaneously.
- KLF 050:** This interface is placed behind a conventional wall switch (not supplied). This will enable the user to choose a wall switch design (for operating our electrical products) that matches the other wall switches in the house.
- KLF 200:** Interface to enable the control of VELUX INTEGRA® products by sensors, smart house systems or other external control units that are not io-homecontrol® compatible.
- KLB 100:** Backup Battery for when there are power outages.

VELUX ACTIVE

NEW



KIX 300

This package contains an indoor climate sensor, a departure switch and a VELUX ACTIVE gateway that connects to the Internet. Mobile app is free.



KLA 300

Additional VELUX ACTIVE indoor climate sensor. For data transmission in real time to other house rooms.



KLN 300

Additional VELUX ACTIVE departure switch. Case you have more than one closing access in your home.

Electric Accessories Controls

KSX 100K	Solar conversion Kit
KMG 100K	Motor for GGL/GGU
KUX 110	Unit Control (for 1 motor)
KLI 311/312/313	Wall switch
KLF 050	Swith Interface
KLF 200	Interface
KLB 100	Battery
KIX 300	VELUX ACTIVE package
KLA 300	VELUX ACTIVE rain sensor
KLN 300	VELUX ACTIVE departure switch

Other accessories

Rods, locks, maintenance and repair kits

Maintenance and repair kits

The maintenance of your roof window is extremely important – it must be made at least every 4 years, or whenever it's necessary.



ZZZ 220K
Maintenance kit for roof windows GGL/GGU/GPL/GPU. Consists of: 3 m of ventilation flap foam, 3 m of air filter, 50 ml of lubricate hinges and instruction guide.

Note: For previous generation roof windows please contact VELUX-INT (VELUX A/S).



ZZZ 131KD
Maintenance kit for white painted roof windows finishes. Consists of: 200 ml of special cleaner, 200 ml of maintenance fluid, sponge and instruction guide.



ZZZ 130KD
Maintenance kit for white painted roof windows finishes. Consists of: 1 bottle with 220 ml of white wood lacquer.



ZZZ 133KD
Repair kit for polyurethane and white painted roof windows finishes. Consists of: a bottle with 400 g acrylic filler.



ZZO 129KD
Repair kit for polyurethane and white painted roof windows finishes. Consists of: 1 bottle with 220 ml of polyurethane lacquer.



ZZZ 176KD
Repair kit for pine wood clear varnished roof windows finishes. Consists of: 1 bottle with 220 ml clear wood lacquer.

MSL adapter



ZOZ 213K
Adapter for an MSL solar awning installation in a solar roof window or in a roof window with the KSX 100K solar conversion kit (all sizes of roof windows).

Manual control

Control your roof windows and manual accessories out of reach.



ZCT 200K
Telescopic rod extensible from 100 to 185 cm long to operate roof windows or blinds* placed out of reach.

* To open your roller blind RHL you also need the adapter ZOZ 040.



ZOZ 040
Adapter to operate roller blinds RHL with rod ZCT 200K.

Security and locks

VELUX has two types of locks for the top-operated (centre-pivot) roof windows (GGL/GGU)



ZOZ 012K
Steel lock with key that makes it difficult to access from outside and simultaneously ensures that only people with the key can open it.



Child resistant locking device ZOZ 012K will together with VELUX centre-pivot roof windows GGL, GZL and GGU, in all sizes fulfill the child safety requirement for EN16281:2013.



ZOZ 159K
Steel lock with locking mechanism that makes access from outside difficult, but can be unlocked by anyone inside.

Manual Accessories / Kits

	ZCT 200K	Extensible rod 100–185 cm
	ZCT 100	Extension of 100 cm for ZCT 200K
	ZCZ 080K	Extensible rod 80 cm
	ZOZ 040	Adaptor for RHL blind
	ZOZ 012K	Window lock
	ZOZ 159K	Steel Lock with bolt
	ZZZ 220K	Maintenance kit for GGL/GGU & GPL/GPU
	ZZZ 131KD	Maintenance kit for white painted RW
	ZZZ 130KD	Repair Kit for white painted RW
	ZZZ 133KD	Repair Kit for white painted and polyurethane RW
	ZZZ 129KD	Repair Kit for polyurethane RW
	ZZZ 176KD	Repair Kit for pine wood varnished RW
	ZOZ 213K	Adaptor for installation of a MSL in a solar roof window

New Generation Sun Tunnel

Natural light where you never thought it would reach



Its flat shape provides a discreet and harmonious installation in your roof, flush with the tiles.



Solution for flat roofs



New diffuser with "EdgeGlow" design, a ring of clear glass that ensures a better spread of daylight in the room.



Flexi-loc: a new way to assemble the rigid tube. More flexibility, easy assembly and less time for installation.



Possible to install from the outside



Diffuser glass removes easier for cleaning.

How to choose the perfect Sun Tunnel

1 What is your roof pitch?



TWF / TWR

Sun Tunnel to install in roofs with a pitch between 15–60 degrees. Available with a 35 cm flexible tube or with rigid tube of 25 or 35 cm. Composed by standard reinforced 4mm pane, in a polyurethane frame with integrated flashing, reflective tube and integrated white diffuser with double polycarbonate glass for ceiling placement. Vapor barrier included.

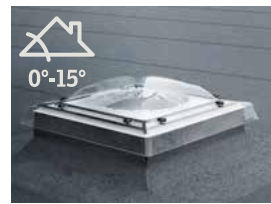

TCF / TCR

Sun Tunnel for flat roofs installation in roofs with a pitch between 0 up to 15 degrees. Available with flexible tube or 35 cm rigid tube. Composed by a roof module in PVC with an acrylic dome, reflector tube and integrated white diffuser frame with double glass in polycarbonate for ceiling placement. Vapor barrier included.

2 Flexible or rigid tube?



TWF – Flexible tube for installations between 0,4 m and 2 m.

TWR – Rigid tube for installations between 0,9 m and 1,7 m for whenever it's necessary to achieve lengths of up to 6 m.



TCF – Flexible tube for installations between 0,4 m and 0,9 m.

TCR – Rigid tube for installations between 0,9 m and 1,7 m for whenever it's necessary to achieve lengths of up to 6 m.

Sun Tunnels for sloped roofs

TWR OK10 2010 Rigid ST, ø 25 cm

TWR OK14 2010 Rigid ST, ø 35 cm

TWF OK14 2010 Flex ST, ø 35 cm

Sun Tunnels for flat roofs

TCR OK14 0010 Rigid ST, ø 35 cm

TCF OK14 0010 Flex ST, ø 35 cm

3 Add necessary accessories (see next page)

Want just one focus of natural light during daytime and an artificial light at night

Light Kit ZTL

Want to improve both interior and exterior insulation

Underfelt collar BFX

The tube delivered is not enough for the distance I have

Rigid extensions ZTR

Need ventilation in the room

Ventilation kit ZVT

Additional accessories for Sun Tunnels



Light kit ZTL

Placed inside the Sun Tunnel just above the diffuser. Have one source of light in your room: natural light during the day and artificial light during the night. Electrical power needed. Includes LED lamp of 4 W (maximum allowed 10 W).



Underfelt collar BDX

For an even better installation of the Sun Tunnel on the roof. With an elastic on the upper part for an easier and more tight installation. Only for installation on sloped roofs.

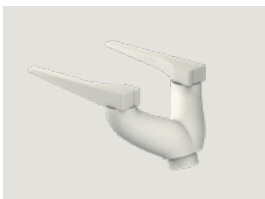

Ventilation kit ZTV

Connection to the back part of the Sun Tunnel's roof module. This system channels air into the room.

Note: Mechanical ventilator and ventilation tube are not included. It's not possible to install on a Sun Tunnel with 25 cm neither in Sun Tunnels for flat roof windows.



Rigid extensions ZTR

If the supplied tubes with the Sun Tunnel are not sufficient, you can choose to add one or more highly reflective aluminum rigid extension. Also available with the Flexi-loc system for an easier and faster installation. Available in two sizes: 62 and 124 cm.

Extensions for Rigid Sun Tunnels		∅ 35 cm
ZTR OK14 0062	(62 cm)	✓
ZTR OK14 0124	(124 cm)	✓

Accessories for Sun Tunnels		∅ 35 cm
ZTL 014L	Light Kit	✓
ZTV 014L	Ventilation Outlet	✓
BFX	Underroof Collar	✓

* Only for Sun Tunnels installed in a slope roof.



Flat roof window

The best solution for a flat roof installation

Revolutionary curved glass



The flat roof window became more elegant with the new curved glass!

- Elegant solution for visible installations
- Glass until the edges for a good drainage
- Low-maintenance
- Construction with 3 panes (interior double pane + curved glass) ensures a good energy performance – U_w -Value = 1,2
- Curved glass up to 6 mm scratch proof
- For flat roof windows with roof pitch between 0 up to 15 degrees
- Available for all sizes, except 150x150

Note: The curved glass cannot be installed in a manual CVP, flat exit roof window CXP neither smoke ventilation roof window CSP.

1 Choose the flat roof window model you need

CVP electric



The electric flat roof window is controlled with the pre-paired wall switch remote control and a rain sensor, that closes the roof window automatically in case of rain.



The electric CVP includes the KLI 311 pre-paired wall switch remote control.

CVP manual



The manual flat roof window is operated with a telescopic rod (extensible up to 190 cm that can be removed) which allows the opening of the flat roof window.

CFP fixed



The fixed flat roof window doesn't open. No ventilation is possible. Ideal for when the objective is just to have daylight coming into the house.

CXP exit



For outside access. The exit flat roof window is manually operated and opens in a 60 degree angle to ensure safety passage. For safety reasons the frame is automatically locked when open.

To be able to know which accessories and upper elements you can install in each flat roof window please consult the compatibilities next page.

2 Choose the upper element



Curved glass
ISD 1093



Flat glass
ISD 2093



Clear acrylic dome ISD 0000
Clear polycarbonate dome ISD 0010



Opaque acrylic dome ISD 0100
Opaque polycarbonate dome ISD 0110

The flat and curved glass aren't available for size 150x150.

Note: When placing an order always mention the dome reference. It's recommended to use the flat glass in installations for roof with pitch between 2–15 degrees.

Compatibility table

	CVP electric			CFP			CVP manual	CXP	CSP
	Curved glass	Flat glass	Dome Acrylic/ Polycarbonate	Curved glass	Flat glass	Dome Acrylic/ Polycarbonate	Dome Acrylic/ Polycarbonate	Dome Acrylic/ Polycarbonate	Dome Acrylic/ Polycarbonate
FMG	✓	✓	✓	✓ + KUX 110	✓ + KUX 110	✓ + KUX 110	-	-	-
FMK	✓	✓	✓	✓ + KUX 110	✓ + KUX 110	✓ + KUX 110	-	-	-
FSK**	✓	✓	✓	✓	✓	✓	-	✓	✓*
MSG**	✓	-	✓	✓	-	✓	✓	-	✓*

✓ = Compatible

* It's necessary the approval of the competent authorities before installation.

** It's not recommended to install solar powered products with opaque acrylic/polycarbonate dome because the battery will not be charged. KUX 110 it's a unit control to operate electric products. It's sold separately.

3 Add the accessories that will create the environment to your liking

Plated blind



A very elegant and practical decorative blind. It allows the soft light entry proving privacy and safety against the direct sunlight.

FMG electric: connected directly to the electric flat roof window. For installation in a fixed flat roof window it will be necessary to acquire the KUX 110 unit control. Available for all sizes except 150x150.

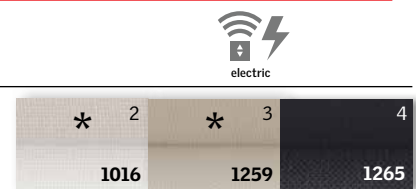

* Standard colors: 1016, 1259

Double-pleated blind



Double-pleated blind with an aluminum layer inside for better insulation. The fabric doesn't allow the entry of light, however the blind is not totally blackout.

FMK electric: connected directly to the electric flat roof window. For installation in a fixed flat roof window it will be necessary to acquire the KUX 110 unit control.

FSK solar: Wall switch pre-paired KLI 312 remote control included. The battery will not be charged if you have an opaque dome installed or when the awning MSG is closed. Available for all sizes.

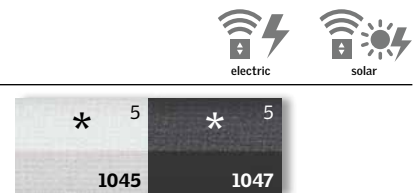

* Standard colors: 1045

Exterior awning

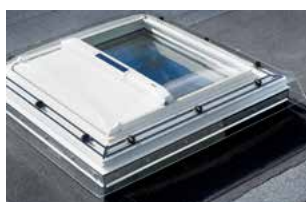

The awning is installed (from the outside) between the double glass of the flat roof window and the upper element, helping to reduce the entry of heat. Maintain a comfortable inside climate with an effective heat protection up to 76 %.

MSG solar: Wall switch pre-paired KLI 313 remote control included. The battery will not be charged if you have an opaque dome installed Available for all sizes except 150x150.

Always indicate the dome – clear acrylic dome (ISD 0000), opaque acrylic dome (ISD 0100), clear polycarbonate dome (ISD 0010), opaque polycarbonate dome (ISD 0110), curved glass (ISD 1093) or flat glass (ISD 2093).

Sizes in cm Window models	60x60 060060	60x90 060090	80x80 080080	90x90 090090	90x120 090120	100x100 100100	100x150 100150	120x120 120120	150x150 150150
Flat Roof Windows with clear or opaque acrylic domes:									
CFP+ISD – Fixed window and dome	✓	✓	✓	✓	✓	✓	✓	✓	✓
CVP INTEGRA® – Electric operated	✓	✓	✓	✓	✓	✓	✓	✓	✓
CVP+ISD – Vented manually operated	✓	✓	✓	✓	✓	✓	✓	✓	-
New "burglary proof" flat roof windows with clear or opaque acrylic domes:									
CFP+ISD – "burglary proof" fixed RW	✓	✓	✓	✓	✓	✓	✓	✓	✓
CVP+ISD – "burglary proof" vented RW	✓	✓	✓	✓	✓	✓	✓	✓	✓
CXP+ ISD – Fixed window and dome	-	-	-	-	✓	✓	-	✓	-
Blinds for flat roof windows									
FMG – electric pleated blind	✓	✓	✓	✓	✓	✓	✓	✓	-
FMK – electric double pleated blind	✓	✓	✓	✓	✓	✓	✓	✓	-
FSK – solar double pleated blind	✓	✓	✓	✓	✓	✓	✓	✓	-
MSG – Solar powered awning blind	✓	✓	✓	✓	✓	✓	✓	✓	-

VELUX INTERNATIONAL (VELUX A/S)
Aadalsvej 99
DK-2970 Horsholm
Denmark
Tel: +45 45 16 78 85
Tel: +45 45 16 40 71
Tel: +45 45 16 79 26
velux-int@velux.com
www.velux.com

Bringing light to life™

VELUX®